

# STAMFORD<sup>®</sup>

## PI734E - Technical Data Sheet

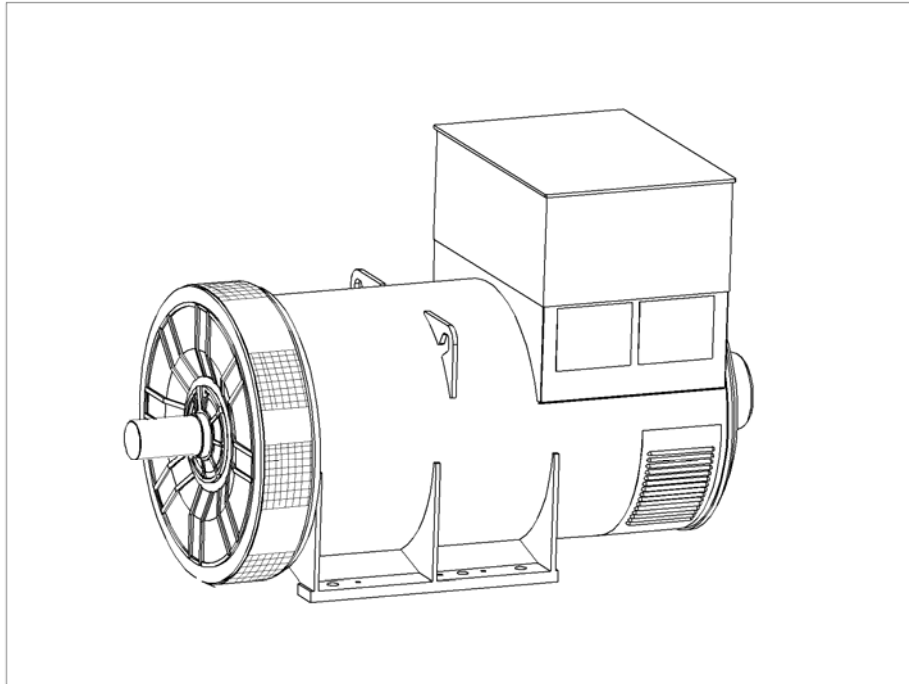

## SPECIFICATIONS &amp; OPTIONS

## STANDARDS

Newage Stamford industrial generators meet the requirements of BS EN 60034 and the relevant sections of other national and international standards such as BS5000, VDE 0530, NEMA MG1-32, IEC60034, CSA C22.2-100, AS1359.

Other standards and certifications can be considered on request.

## DESCRIPTION

The STAMFORD PI range of synchronous ac generators are brushless with a rotating field. They are separately excited by the STAMFORD Permanent Magnet Generator (PMG). This is a shaft mounted, high frequency, pilot exciter which provides a constant supply of clean power via the Automatic Voltage Regulator (AVR) to the main exciter. The main exciter output is fed to the main rotor, through a full wave bridge rectifier, protected by surge suppression.

## VOLTAGE REGULATORS

The PI range generators, complete with a PMG, are available with one of two AVRs. Each AVR has soft start voltage build up and built in protection against sustained over-excitation, which will de-excite the generator after a minimum of 8 seconds.

Underspeed protection (UFRO) is also provided on both AVRs. The UFRO will reduce the generator output voltage proportional to the speed of the generator below a pre-settable level.

The **MX341 AVR** is two phase sensed with a voltage regulation of  $\pm 1\%$ . (see the note on regulation).

The **MX321 AVR** is 3 phase rms sensed with a voltage regulation of 0.5% rms (see the note on regulation). The UFRO circuit has adjustable slope and dwell for controlled recovery from step loads. An over voltage protection circuit will shutdown the output device of the AVR, it can also trip an optional excitation circuit breaker if required. As an option, short circuit current limiting is available with the addition of current transformers.

Both the MX341 and the MX321 need a generator mounted current transformer to provide quadrature droop characteristics for load sharing during parallel operation. Provision is also made for the connection of the STAMFORD power factor controller, for embedded applications, and a remote voltage trimmer.

## WINDINGS &amp; ELECTRICAL PERFORMANCE

All generator stators are wound to 2/3 pitch. This eliminates triplen (3rd, 9th, 15th ...) harmonics on the voltage waveform and is found to be the optimum design for trouble-free supply of non-linear loads. The 2/3 pitch design avoids excessive neutral currents sometimes seen with higher winding pitches. A fully connected damper winding reduces oscillations during paralleling. This winding, with the 2/3 pitch and carefully selected pole and tooth designs, ensures very low levels of voltage waveform distortion.

## TERMINALS &amp; TERMINAL BOX

Standard generators feature a main stator with 6 ends brought out to the terminals, which are mounted on the frame at the non-drive end of the generator. A sheet steel terminal box contains the AVR and provides ample space for the customers' wiring and gland arrangements. It has removable panels for easy access.

## SHAFT &amp; KEYS

All generator rotors are dynamically balanced to better than BS6861:Part 1 Grade 2.5 for minimum vibration in operation. Two bearing generators are balanced with a half key.

## INSULATION/IMPREGNATION

The insulation system is class 'H', and meets the requirements of UL1446.

All wound components are impregnated with materials and processes designed specifically to provide the high build required for static windings and the high mechanical strength required for rotating components.

## QUALITY ASSURANCE

Generators are manufactured using production procedures having a quality assurance level to BS EN ISO 9001.

## NOTE ON REGULATION

The stated voltage regulation may not be maintained in the presence of certain radio transmitted signals. Any change in performance will fall within the limits of Criteria 'B' of EN 61000-6-2:2001. At no time will the steady-state voltage regulation exceed 2%.

Note: Continuous development of our products entitles us to change specification details without notice, therefore they must not be regarded as binding.

Front cover drawing is typical of the product range.

**PI734E**  
**WINDING 312**

**STAMFORD**

CONTROL SYSTEM	SEPARATELY EXCITED BY P.M.G.		
A.V.R.	MX341	MX321	
VOLTAGE REGULATION	± 1 %	± 0.5 %	With 4% ENGINE GOVERNING
SUSTAINED SHORT CIRCUIT	REFER TO SHORT CIRCUIT DECREMENT CURVES (page 7)		

INSULATION SYSTEM	CLASS H							
PROTECTION	IP23							
RATED POWER FACTOR	0.8							
STATOR WINDING	DOUBLE LAYER LAP							
WINDING PITCH	TWO THIRDS							
WINDING LEADS	6							
MAIN STATOR RESISTANCE	0.00093 Ohms PER PHASE AT 22°C STAR CONNECTED							
MAIN ROTOR RESISTANCE	2.17 Ohms at 22°C							
EXCITER STATOR RESISTANCE	17.5 Ohms at 22°C							
EXCITER ROTOR RESISTANCE	0.063 Ohms PER PHASE AT 22°C							
R.F.I. SUPPRESSION	BS EN 61000-6-2 & BS EN 61000-6-4, VDE 0875G, VDE 0875N. refer to factory for others							
WAVEFORM DISTORTION	NO LOAD < 1.5% NON-DISTORTING BALANCED LINEAR LOAD < 5.0%							
MAXIMUM OVERSPEED	2250 Rev/Min							
BEARING DRIVE END	BALL. 6228 C3							
BEARING NON-DRIVE END	BALL. 6319 C3							
	1 BEARING				2 BEARING			
WEIGHT COMP. GENERATOR	3556 kg				3506 kg			
WEIGHT WOUND STATOR	1747 kg				1747 kg			
WEIGHT WOUND ROTOR	1494 kg				1432 kg			
WR <sup>2</sup> INERTIA	45.49 kgm <sup>2</sup>				44.4891 kgm <sup>2</sup>			
SHIPPING WEIGHTS in a crate	3629kg				3575kg			
PACKING CRATE SIZE	216 x 105 x 154(cm)				216 x 105 x 154(cm)			
	50 Hz				60 Hz			
TELEPHONE INTERFERENCE	THF<2%				TIF<50			
COOLING AIR	2.69 m <sup>3</sup> /sec 5700 cfm				3.45 m <sup>3</sup> /sec 7300 cfm			
VOLTAGE STAR	380/220	400/231	415/240	440/254	416/240	440/254	460/266	480/277
kVA BASE RATING FOR REACTANCE VALUES	1845	1900	1900	1865	2070	2210	2255	2300
X <sub>d</sub> DIR. AXIS SYNCHRONOUS	3.18	2.96	2.75	2.40	3.84	3.67	3.42	3.21
X' <sub>d</sub> DIR. AXIS TRANSIENT	0.19	0.18	0.17	0.15	0.23	0.22	0.21	0.19
X'' <sub>d</sub> DIR. AXIS SUBTRANSIENT	0.14	0.13	0.12	0.11	0.17	0.16	0.15	0.14
X <sub>q</sub> QUAD. AXIS REACTANCE	2.04	1.90	1.76	1.54	2.47	2.36	2.20	2.06
X'' <sub>q</sub> QUAD. AXIS SUBTRANSIENT	0.29	0.27	0.25	0.22	0.35	0.33	0.31	0.29
X <sub>L</sub> LEAKAGE REACTANCE	0.04	0.03	0.03	0.03	0.04	0.04	0.04	0.04
X <sub>2</sub> NEGATIVE SEQUENCE	0.20	0.19	0.17	0.15	0.24	0.23	0.22	0.20
X <sub>0</sub> ZERO SEQUENCE	0.02	0.02	0.02	0.02	0.03	0.03	0.03	0.03
REACTANCES ARE SATURATED				VALUES ARE PER UNIT AT RATING AND VOLTAGE INDICATED				
T' <sub>d</sub> TRANSIENT TIME CONST.	0.149s							
T'' <sub>d</sub> SUB-TRANSTIME CONST.	0.02s							
T <sub>do</sub> O.C. FIELD TIME CONST.	2.46s							
T <sub>a</sub> ARMATURE TIME CONST.	0.02s							
SHORT CIRCUIT RATIO	1/X <sub>d</sub>							

50  
Hz

PI734E  
Winding 312

**STAMFORD**

**THREE PHASE EFFICIENCY CURVES**

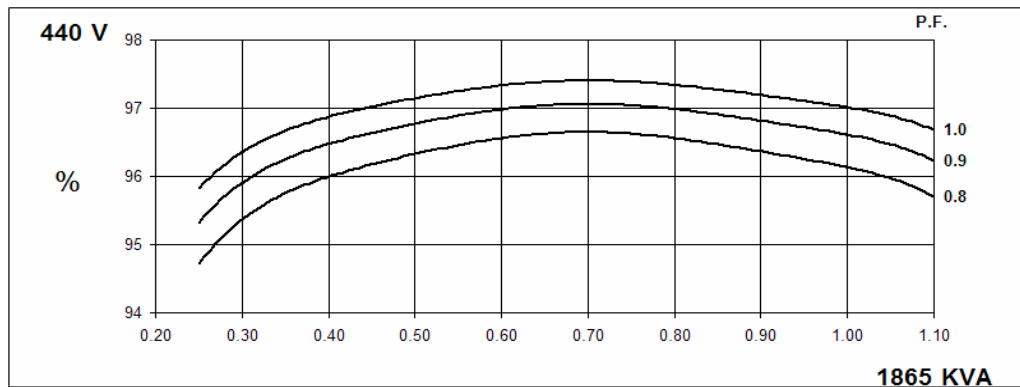
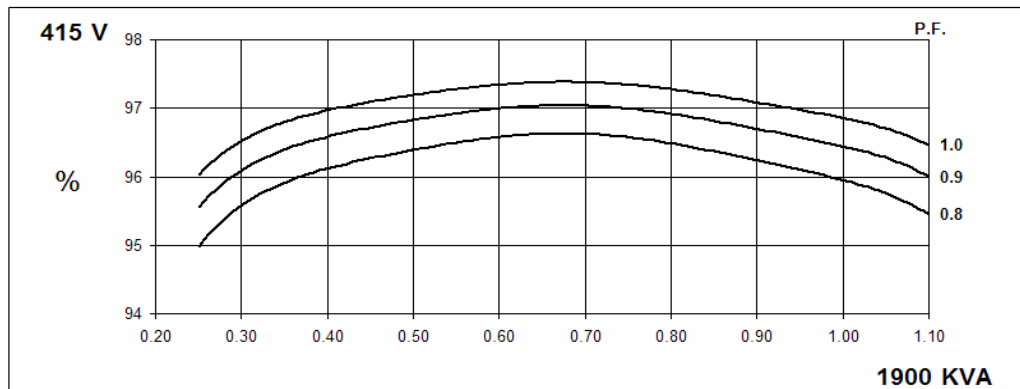
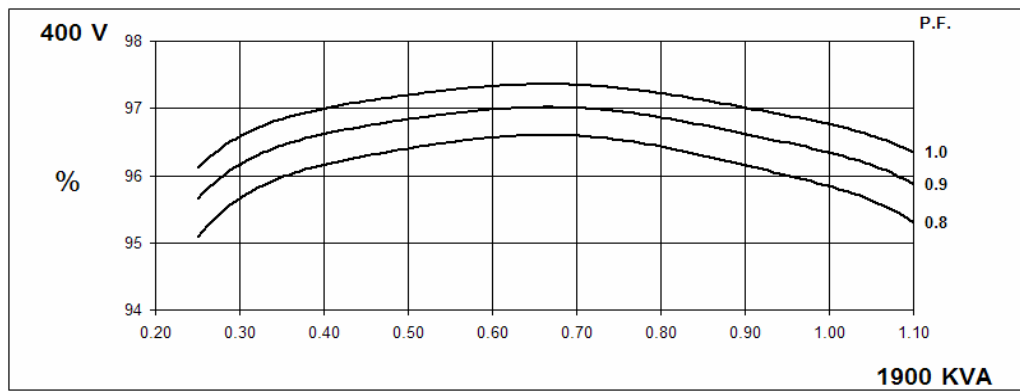
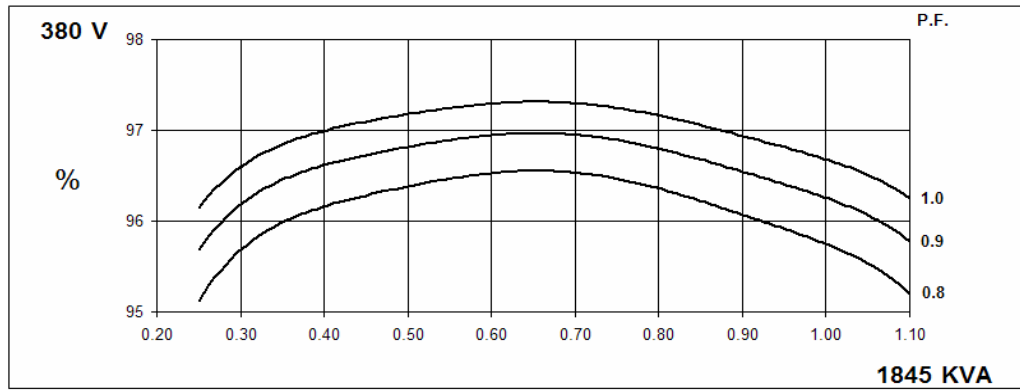

60  
Hz

PI734E  
Winding 312

**STAMFORD**

**THREE PHASE EFFICIENCY CURVES**

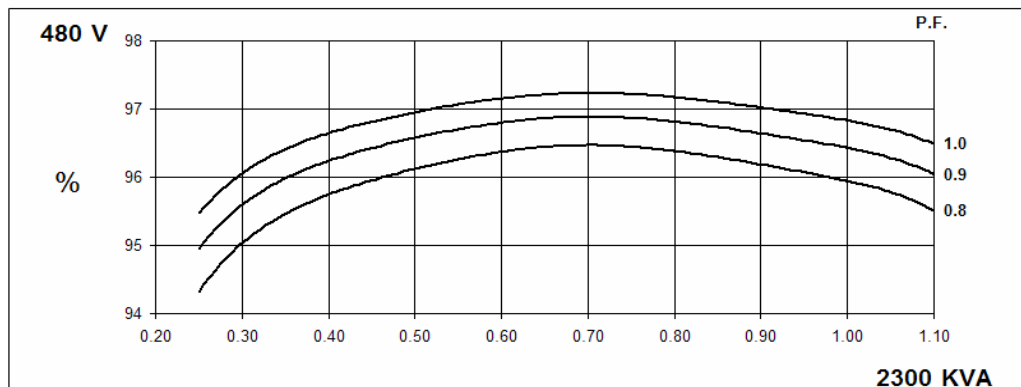
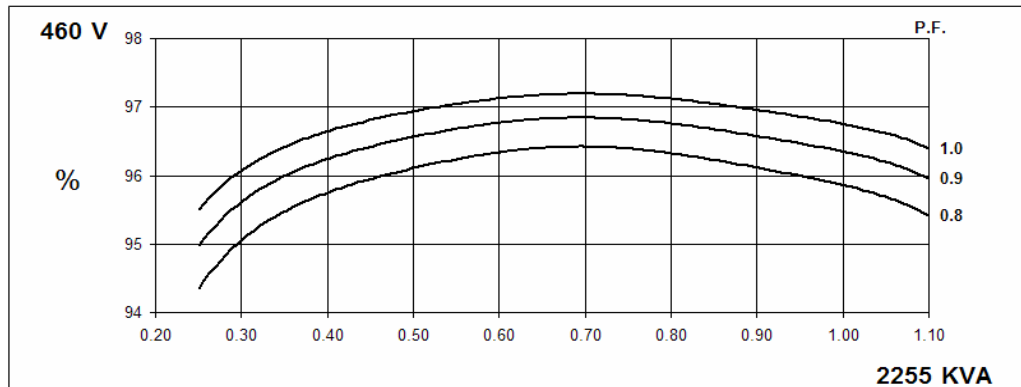
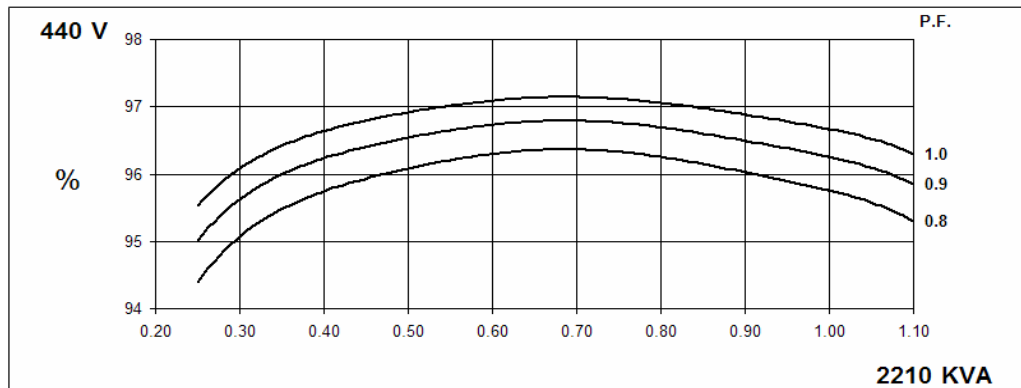
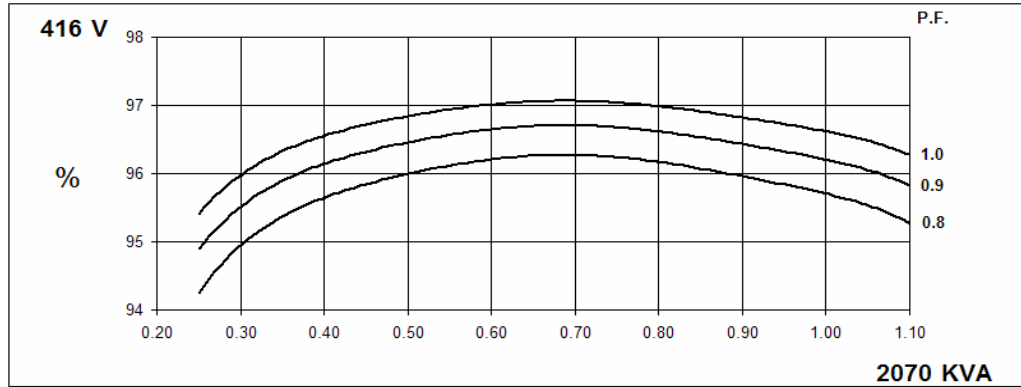

PI734E  
Winding 312

**STAMFORD**

**Locked Rotor Motor Starting Curve**

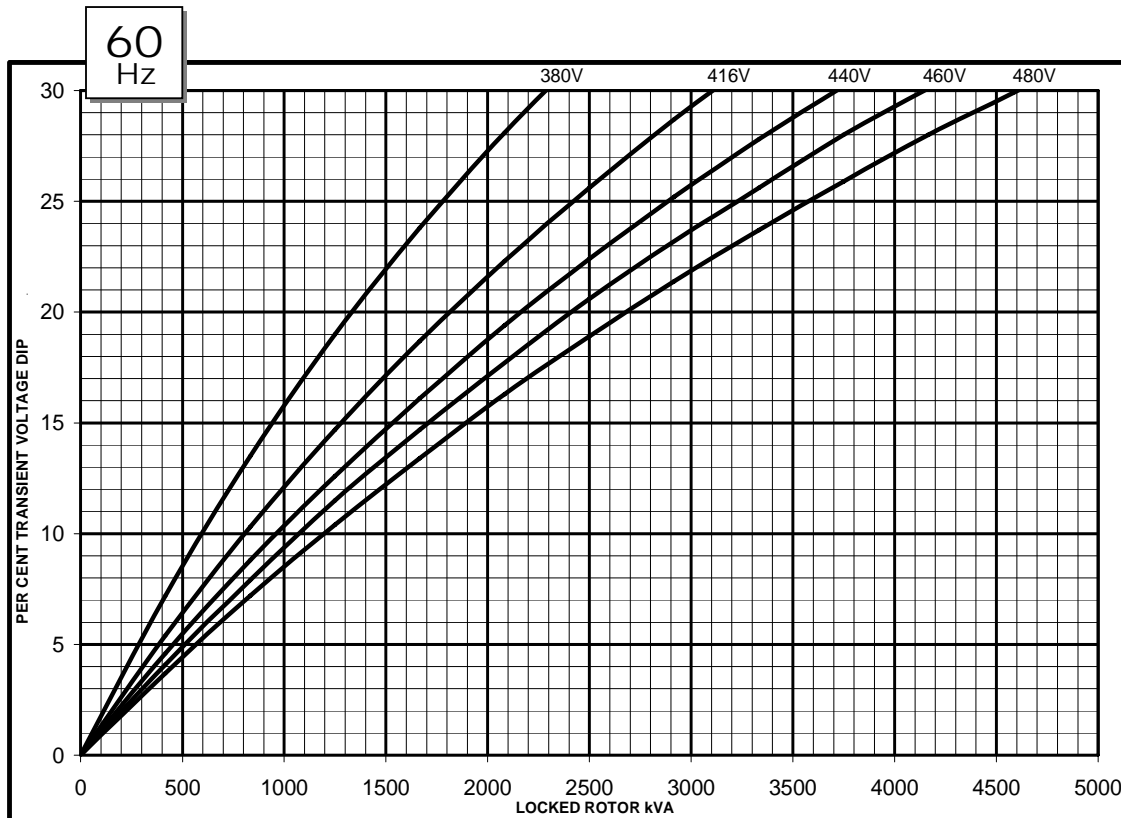
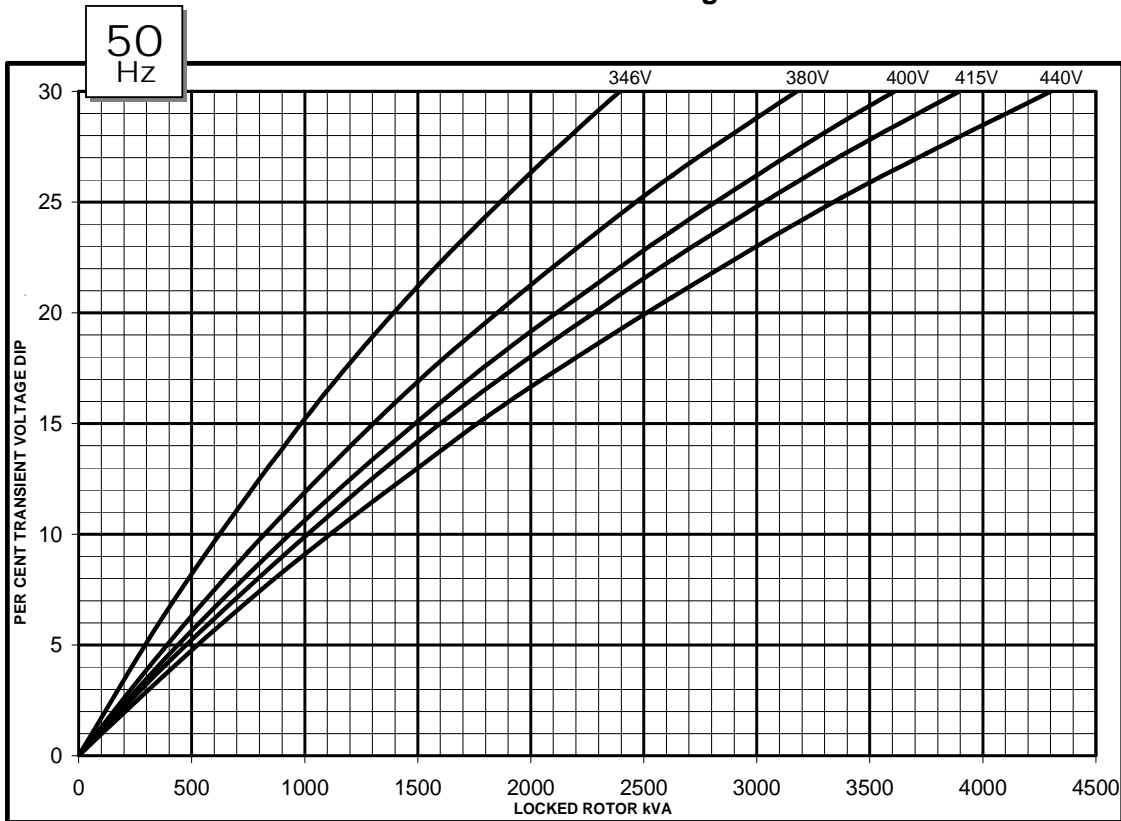

**Three-phase Short Circuit Decrement Curve. No-load Excitation at Rated Speed  
Based on star (wye) connection.**

**50  
Hz**

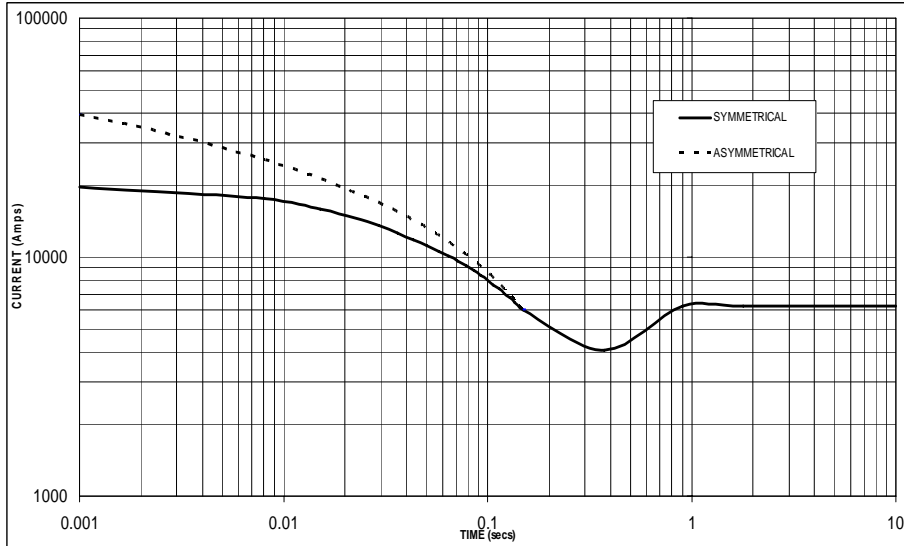

Sustained Short Circuit = 6,250 Amps

**60  
Hz**

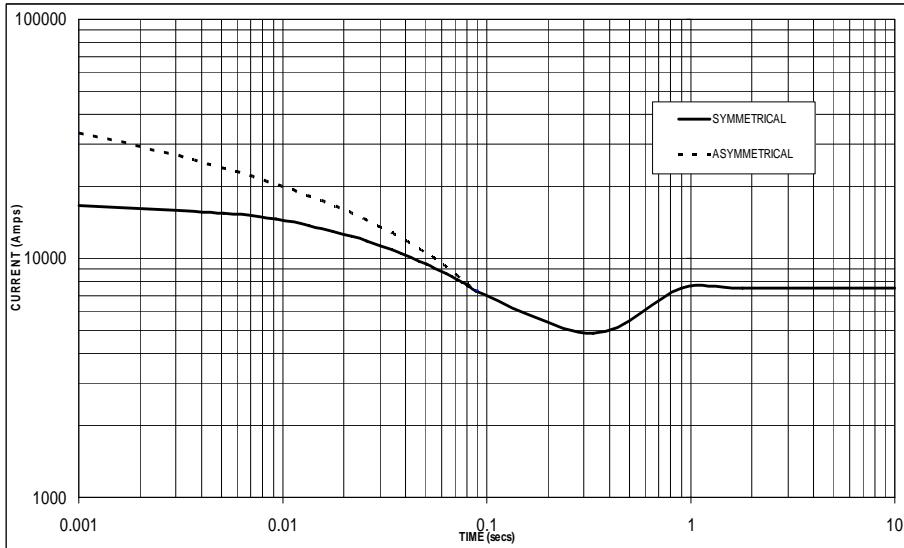

Sustained Short Circuit = 7,500 Amps

**Note 1**

The following multiplication factors should be used to adjust the values from curve between time 0.001 seconds and the minimum current point in respect of nominal operating voltage :

50Hz		60Hz	
Voltage	Factor	Voltage	Factor
380v	x 1.00	416v	x 1.00
400v	x 1.05	440v	x 1.06
415v	x 1.09	460v	x 1.10
440v	x 1.16	480v	x 1.15

The sustained current value is constant irrespective of voltage level

**Note 2**

The following multiplication factor should be used to convert the values calculated in accordance with NOTE 1 to those applicable to the various types of short circuit :

	3-phase	2-phase L-L	1-phase L-N
Instantaneous	x 1.00	x 0.87	x 1.30
Minimum	x 1.00	x 1.80	x 3.20
Sustained	x 1.00	x 1.50	x 2.50
Max. sustained duration	10 sec.	5 sec.	2 sec.

All other times are unchanged

**Note 3**

Curves are drawn for Star (Wye) connected machines.

**PI734E**  
**Winding 312 / 0.8 Power Factor**

**RATINGS**

Class - Temp Rise		Cont. F - 105/40°C				Cont. H - 125/40°C				Standby - 150/40°C				Standby - 163/27°C			
<b>50Hz</b>	Star (V)	380	400	415	440	380	400	415	440	380	400	415	440	380	400	415	440
	kVA	1715	1770	1770	1735	1845	1900	1900	1865	1920	1980	1980	1940	1975	2035	2035	1995
	kW	1372	1416	1416	1388	1476	1520	1520	1492	1536	1584	1584	1552	1580	1628	1628	1596
	Efficiency (%)	95.9	96.0	96.1	96.3	95.7	95.8	96.0	96.1	95.6	95.7	95.8	96.1	95.5	95.6	95.8	96.0
	kW Input	1431	1475	1473	1441	1542	1587	1583	1553	1607	1655	1653	1615	1654	1703	1699	1663

<b>60Hz</b>	Star (V)	416	440	460	480	416	440	460	480	416	440	460	480	416	440	460	480
	kVA	1935	2055	2100	2140	2070	2210	2255	2300	2155	2300	2345	2395	2215	2365	2415	2465
	kW	1548	1644	1680	1712	1656	1768	1804	1840	1724	1840	1876	1916	1772	1892	1932	1972
	Efficiency (%)	95.8	95.9	96.0	96.1	95.7	95.8	95.9	95.9	95.6	95.7	95.8	95.9	95.5	95.6	95.7	95.8
	kW Input	1616	1714	1750	1781	1730	1846	1881	1919	1803	1923	1958	1998	1855	1979	2019	2058

**DIMENSIONS**

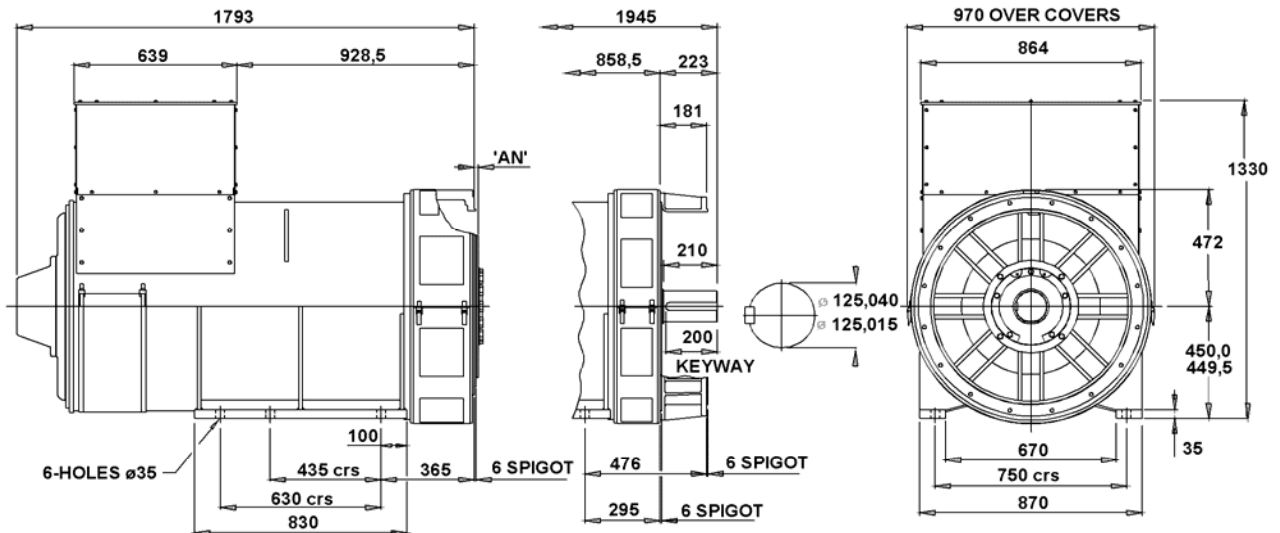

COUPLING DISC	'AN'
S.A.E No 18	15,7
S.A.E No 21	0
S.A.E No 24	0

1-BRG ADAPTORS
S.A.E No 0
S.A.E No 00

2-BRG ADAPTORS
S.A.E No 0
S.A.E No 00